

An/Aus

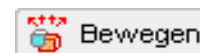

Neue Farbe

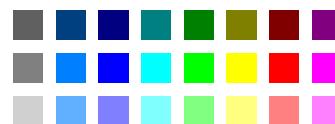

Bewegen

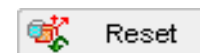

Reset

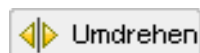

Umdrehen

Explosion / Teile bewegen

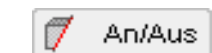

An/Aus



Neue Farbe

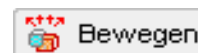
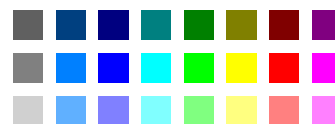

Bewegen

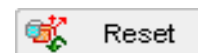

Reset

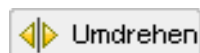

Umdrehen

Explosion / Teile bewegen

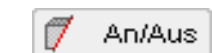

An/Aus



Neue Farbe

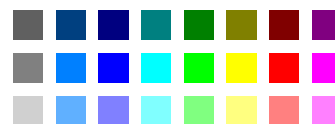

Bewegen

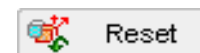

Reset



Umdrehen

Explosion / Teile bewegen

COMMENT:  
 ALL RIGHTS ARE RESERVED BY US FOR THIS DRAWING. WITHOUT OUR PRIOR CONSENT,  
 IT MAY NEITHER BE DUPLICATED NOR MADE AVAILABLE TO A THIRD PARTY,  
 AND IT ALSO MAY NOT BE IMPROPERLY USED BY THE RECEIVER, OR A THIRD PARTY.

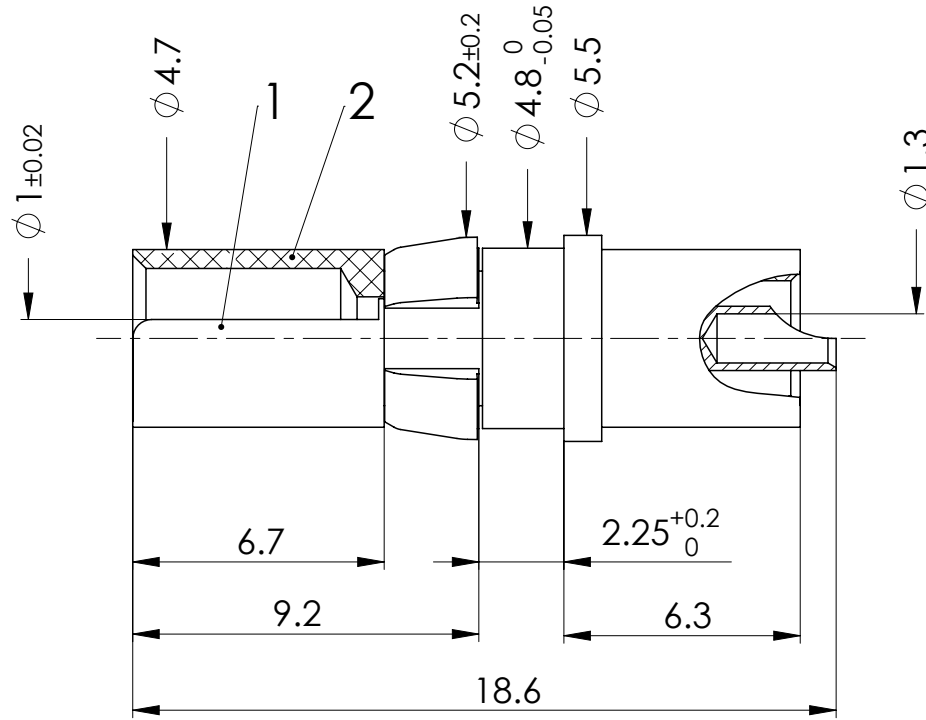
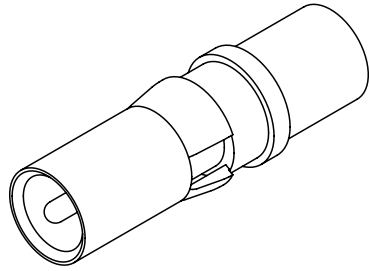

AWG 18			HIGH VOLTAGE CONTACT		SCALE 5:1	PART NO. FMV014S_K	REV. 1
FOR D-SUB or EN 60603-2			NAME / DATE				
DIMENSIONS IN MM			DRAWN	sschref 03-09-2009			
MATERIAL + FINISH SEE EXTRA SHEET			CHECKED	SKusber 19-10-2009			
UNLESS OTHERWISE SPECIFIED DIMENSIONS FOR REFERENCE ONLY			 <a href="http://www.fctgroup.com">www.fctgroup.com</a>				
1	19-10-2009						
REV.	DATE	INDEX	ORIGINAL: DIN A4-DRAWING AS A FILE		REPLACEMENT FOR:		PAGE: 1/1